





**▲ WARNING:**  
Small parts and sharp points may be present prior to assembly.



**Care Instructions**  
To clean your product, use mild soap and water on a damp cloth. Do not use window cleaners or cleaning abrasives as they will scratch the surface and could damage the protective coating.

**HARDWARES:**



- |   |   |      |   |   |       |
|---|---|------|---|---|-------|
| ① |  | 4PCS | ② |  | 4PCS  |
| ③ |  | 6PCS | ④ |  | 2SETS |
| ⑤ |  | 1PC  |   |   |       |

**PRODUCT PARTS:**

ITEM NO: KYW-1376G

A		B		C	
	2PCS		1PC		1PC

**STEP 1**

- |   |   |      |
|---|---|------|
| ② |  | 4PCS |
| ⑤ |  | 1PC  |

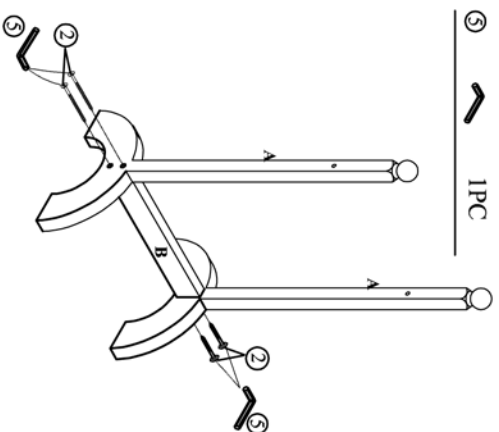

**STEP 2**

- |   |   |       |
|---|---|-------|
| ④ |  | 2SETS |
| ① |  | 4PCS  |
| ③ |  | 6PCS  |

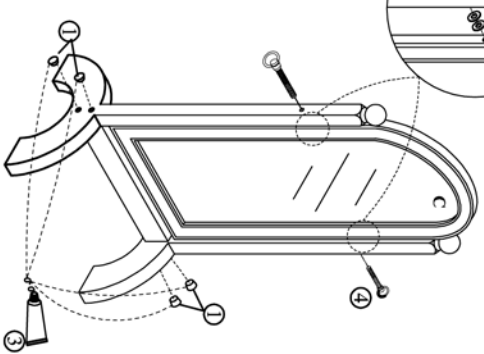
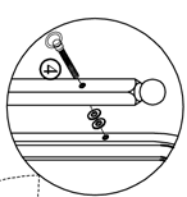

**STEP 3**

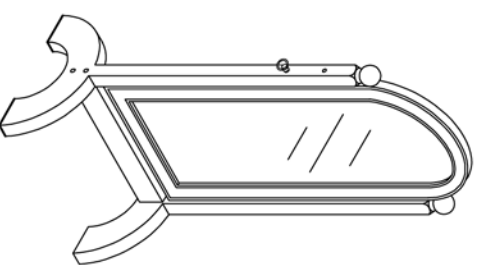

(Finished Product)

MADE IN CHINA